

# Keysight P940xA/C

## Solid State PIN Diode Switches

P9402A 100 MHz to 8 GHz SPDT PIN switch

P9402C 100 MHz to 18 GHz SPDT PIN switch

P9404A 100 MHz to 8 GHz SP4T PIN switch

P9404C 100 MHz to 18 GHz SP4T PIN switch

## Technical Overview

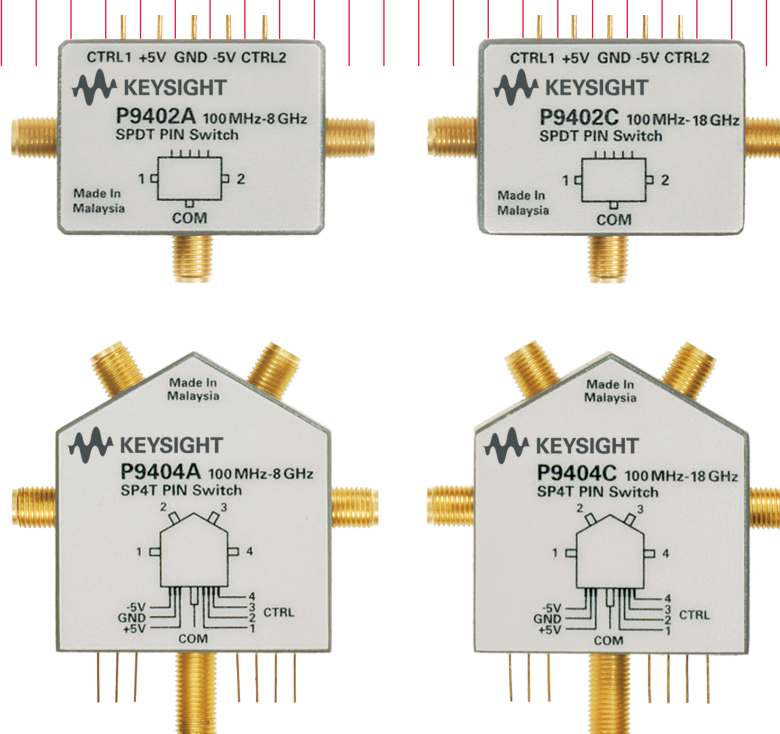

## Key Features

- Dramatically increase throughput with ultra fast switching speed of < 450 ns
- Reduce test system set up costs with the long switching life
- Minimize cross-talk with exceptionally high port-to-port isolation of > 80 dB
- Optimize your system dynamic range with low insertion loss switches, 2.5 dB at 4 GHz, SP4T

## Description

The Keysight Technologies, Inc. P940xA/C absorptive solid state switches, based on PIN diode technology, provide superior performance in terms of isolation, insertion loss and return loss across a broad operating frequency range. The P940xA/C are particularly suitable for high-speed RF and microwave switching applications in instrumentation, communication, radar, switch matrices as well as many other test systems.

The P9402A/C switches have a SPDT PIN diode individual control switch IC and discrete shunt pin diodes on the RF path. The discrete shunt pin diodes enhance the isolation between ports. The switch's individual control pin controls the port between the ON and OFF state. With these features, the switch provides good port match even when it is off. Hence, this SPDT switch has three switching states, switching between the common port and port 1 or port 2 or all ports Off.

The P9404A/C switches have a SP4T PIN diode switch IC and discrete shunt pin diodes on the RF path. The P9404A/C SP4T switches have five switching states, switching between the common port to any one of the 4 output ports or, all ports to the OFF state (terminated at 50 Ohm).

## Application

Solid state switches can be used in a large number of applications, increasing system flexibility and simplifying system design. They are preferred in test systems where speed is critical.

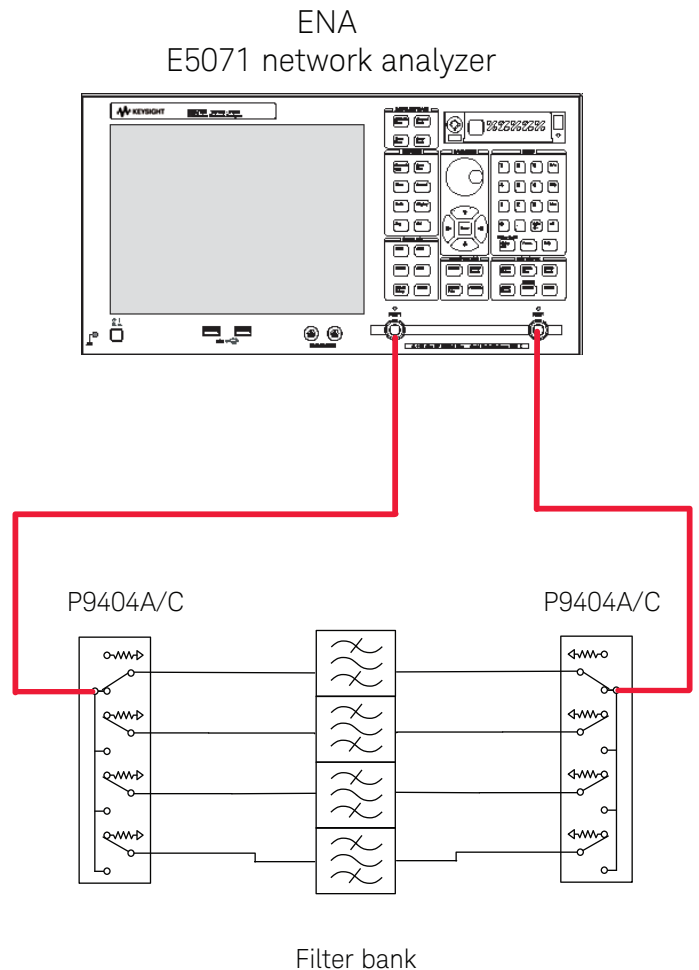

Figure 1. Filter bank test setup

The figure above shows a typical test setup for filter bank testing. Two SP4T absorptive PIN switches are needed for the S parameter measurement with ENA. Mobile handset and semiconductor manufacturers use PIN switches because fast switching speeds are needed for high volume testing of filters e.g. SAW filters. P940xA/C are particularly suitable for the application due to two reasons; the low insertion loss optimizes the dynamic range, and TTL control enables the switches to be controlled easily, using +5V or 0V.

## Specifications

Specifications refer to the performance standards or limits against which the solid state switches are tested.

*Typical characteristics are included for additional information only and they are not specifications. These are denoted as “typical”, “nominal” or “approximate” and are printed in italic.*

### RF Specifications

#### SPDT

Model	P9402A	P9402C
Frequency range	100 MHz to 8 GHz	100 MHz to 18 GHz
Insertion loss	< 2.5 dB (100 MHz to 4 GHz)	< 3.5 dB (100 MHz to 8 GHz)
	< 3.2 dB ( 4 GHz to 8 GHz)	< 4 dB ( 8 GHz to 18 GHz)
Isolation	80 dB	80 dB
Return loss (ON & Common Port)	> 15 dB	> 10 dB
Return loss (OFF Port)	> 15 dB	> 10 dB
Switching speed rise/fall <sup>1</sup>	380 ns (typical)	380 ns (typical)
Video leakage	3400mVpp (typical)	3400mVpp (typical)
Characteristic impedance	50 Ω (nominal)	50 Ω (nominal)
Connectors	SMA (f)	SMA (f)

1. Switching speed is based on 50% TTL to 90% RF.

#### SP4T

Model	P9404A	P9404C
Frequency range	100 MHz to 8 GHz	100 MHz to 18 GHz
Insertion loss	< 2.5 dB (100 MHz to 4 GHz)	< 3.5 dB (100 MHz to 8 GHz)
	< 3.5 dB (4 GHz to 8 GHz)	< 4.5 dB ( 8 GHz to 18 GHz)
Isolation	80 dB	80 dB
Return loss (ON & Common Port)	> 15 dB	> 10 dB
Return loss (OFF Port)	> 15 dB	> 10 dB
Switching speed rise/fall <sup>1</sup>	450 ns (typical)	450 ns (typical)
Video leakage	2800mVpp (typical)	2800mVpp (typical)
Characteristic impedance	50 Ω (nominal)	50 Ω (nominal)
Connectors	SMA (f)	SMA (f)

1. Switching speed is based on 50% TTL to 90% RF.

## Absolute maximum ratings

Parameters	P9402A/C		P9404A/C	
	MIN	MAX	MIN	MAX
RF input power (average)		+23 dBm		+27 dBm
VCC DC Supply Voltage	+4.5 V	+5.5 V	+4.5 V	+5.5 V
VEE DC Supply Voltage	-5.5 V	-4.5 V	-5.5 V	-4.5 V
CTRL input high voltage	+2.4 V	VCC	+2.4 V	VCC
CTRL input low voltage	-0.8 V	+0.8 V	-0.8 V	+0.8 V

Conditions	Nominal current drawn for SPDT <sup>1</sup>		Nominal current drawn for SP4T <sup>2</sup>			Remarks
	+5V pin	-5V pin	Conditions	+5V pin	-5V pin	
Port 1 ON	30mA	25mA	Port 1 ON	90mA	30mA	Either port ON the current drawn at the pin is the same
Port 2 OFF	30mA	25mA	Port 2 OFF	90mA	30mA	Either port ON the current drawn at the pin is the same
Port 1 OFF	30mA	25mA	Port 3 OFF	90mA	30mA	Either port ON the current drawn at the pin is the same
Port 2 ON	30mA	25mA	Port 4 OFF	90mA	30mA	Either port ON the current drawn at the pin is the same
Port 1 and Port 2 OFF	60mA	0mA	All Port OFF	120mA	0mA	

1. Nominal current drawn on respective CTRL pin when Vcc is applied: 12uA

2. Nominal current drawn on respective CTRL pin when Vcc is applied: 8uA

## Environmental Specifications

The P940xA/C PIN diode switches are designed to fully comply with Keysight product operating environment specifications. The following summarizes the environmental specifications for these products.

### Temperature

Operating -55 °C to +95 °C  
 Storage -65 °C to +125 °C  
 Cycling -65 °C to +150 °C, 10 cycles @ 20 °C per minute,  
 20 minutes dwell time per MIL-STD-833F, Method 1010.8,  
 Condition C (modified)

### Humidity

Operating 50% to 95% RH @ 40 °C, one 24 hour cycle, repeated  
 5 times  
 Storage < 90% RH @ 65 °C for 24 hours

### Shock

Half-sine, 1000 G @ 0.5 ms, 3 shock pulses per orientation,  
 18 total smoothed per MIL-STD-833F, Method 2002.4,  
 Condition B (modified)

### Vibration

Broadband, 50 to 2000 Hz, 7.0 G rms, 15 minutes, per  
 MIL-STD-833F, random Method 2026-1 (modified)

### Altitude

Storage < 15,300 meters (50,000 feet)

### ESD immunity

Direct discharge 2.5 kV per IEC 61000-4-2  
 Air discharge 3.5 kV per IEC 61000-4-2

## Mechanical Dimensions

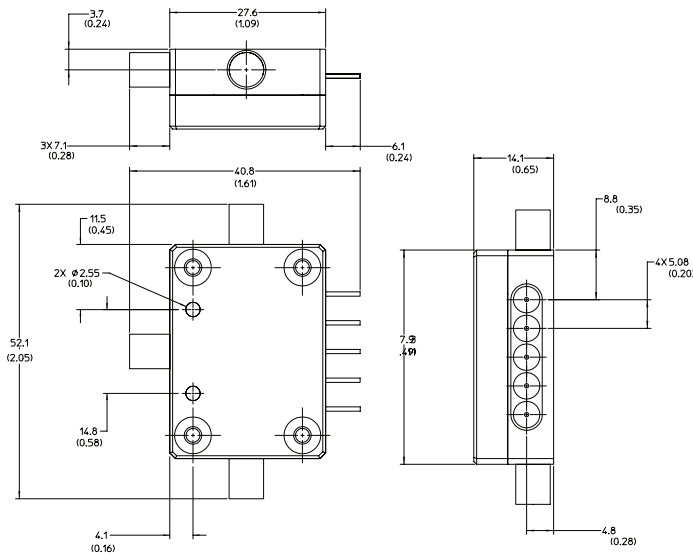

Dimensions in millimeters and inches.

Figure 2. Product dimensions for P9402A/C

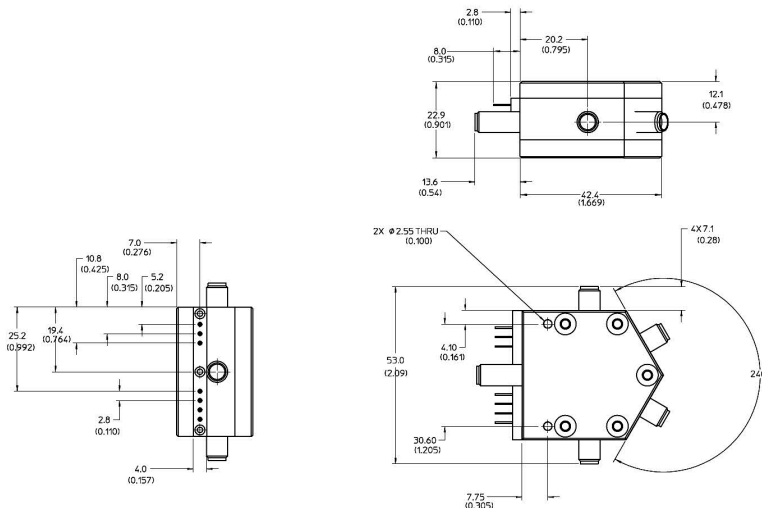

Figure 3. Product dimensions for P9404A/C

Model	Weight
P9402A/C	50 g
P9404A/C	105 g

## Typical performance

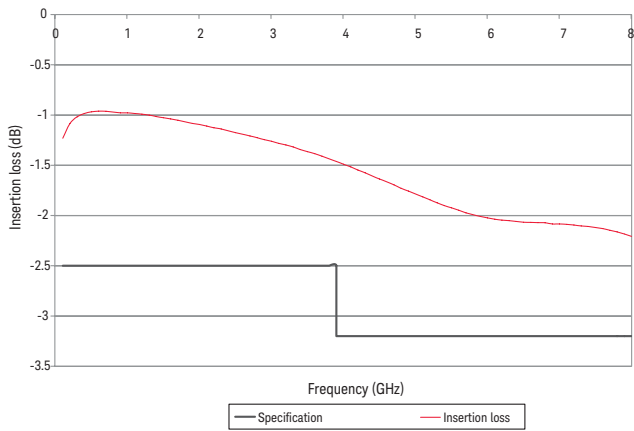

Figure 4. P9402A insertion loss vs. frequency (typical)

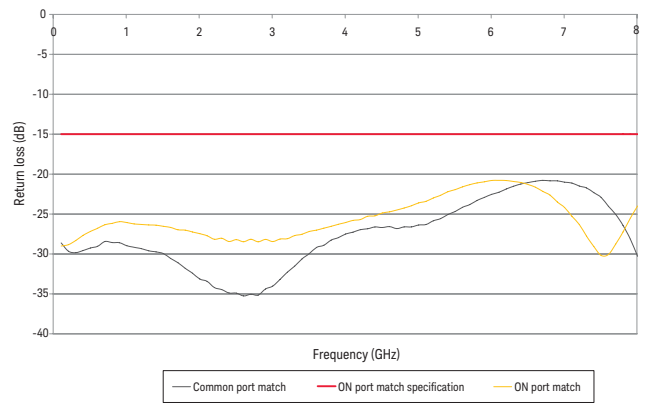

Figure 5. P9402A return loss (ON) vs. frequency (typical)

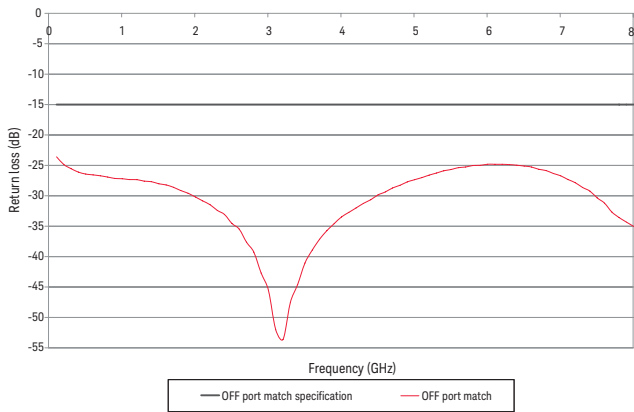

Figure 6. P9402A return loss (OFF) vs. frequency (typical)

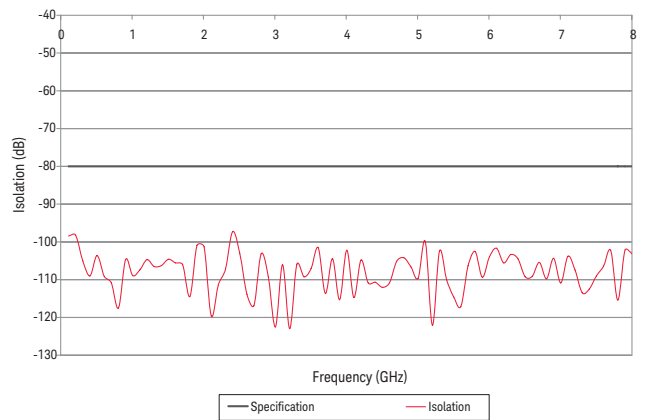

Figure 7. P9402A isolation vs. frequency (typical)

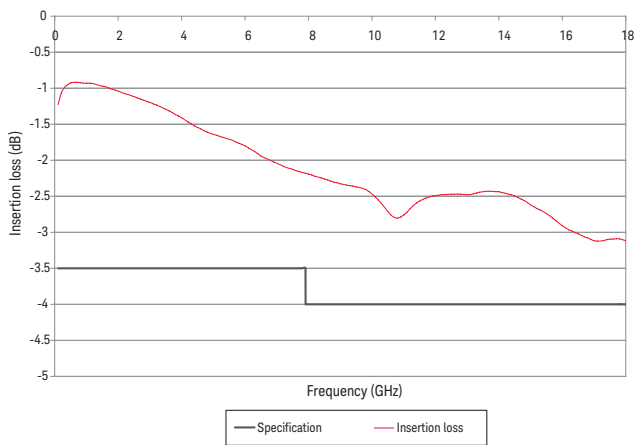

Figure 8. P9402C insertion loss vs. frequency (typical)

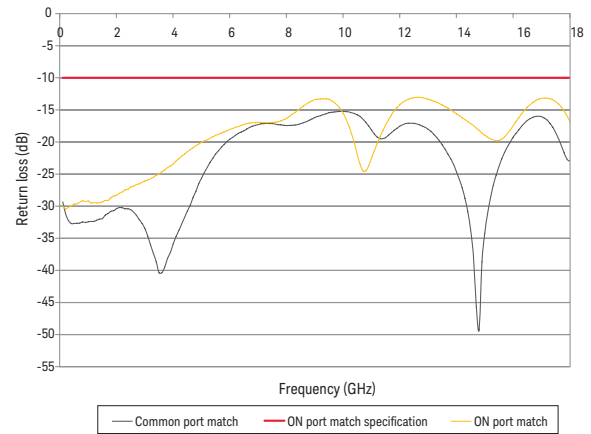

Figure 9. P9402C return loss (ON) vs. frequency (typical)

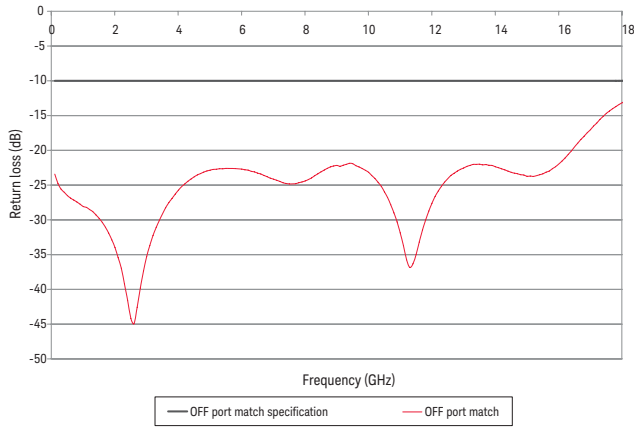

Figure 10. P9402C return loss (OFF) vs. frequency (typical)

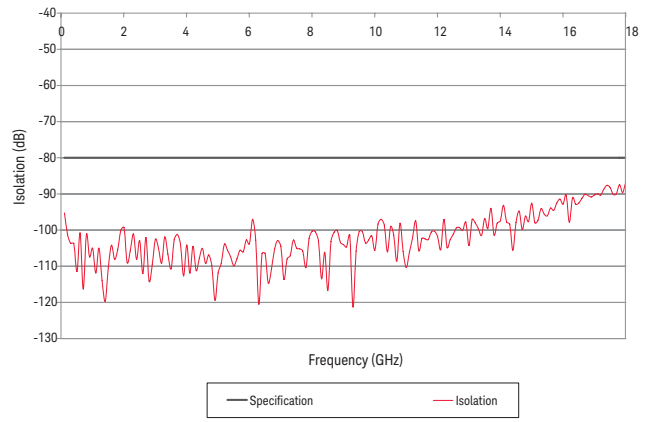

Figure 11. P9402C isolation vs. frequency (typical)

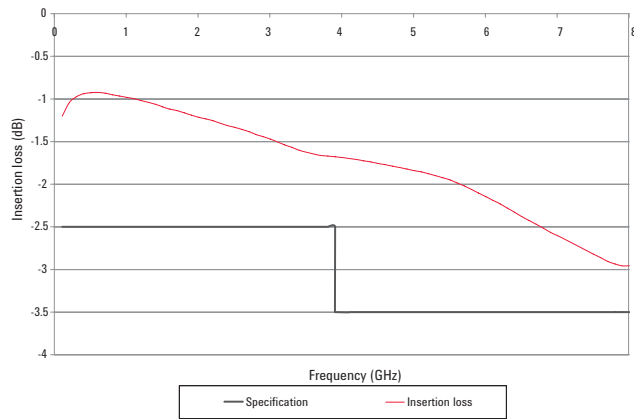

Figure 12. P9404A insertion loss vs. frequency (typical)

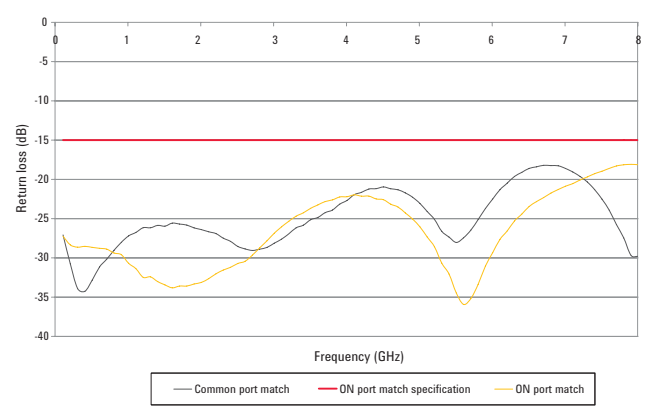

Figure 13. P9404A return loss (ON) vs. frequency (typical)

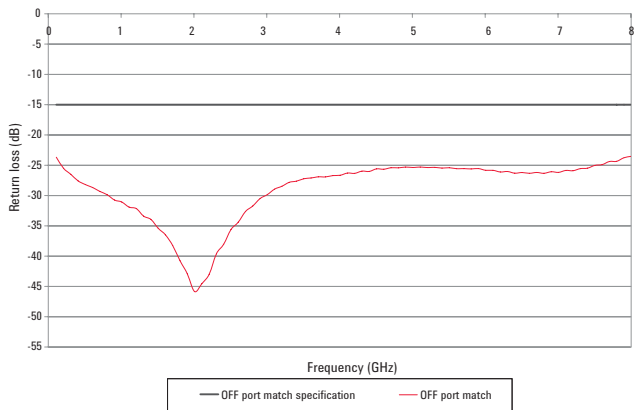

Figure 14. P9404A return loss (OFF) vs. frequency (typical)

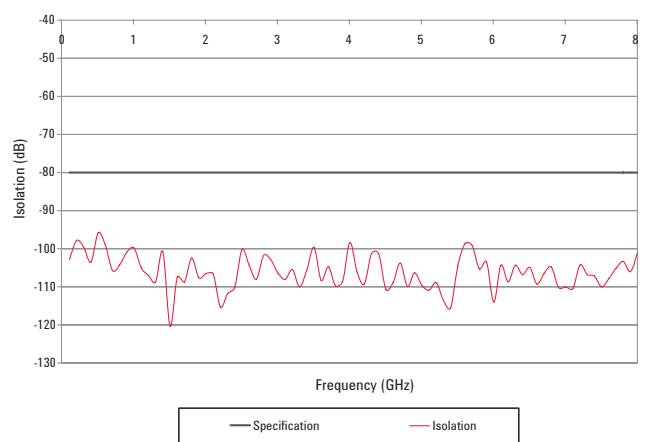

Figure 15. P9404A isolation vs. frequency (typical)

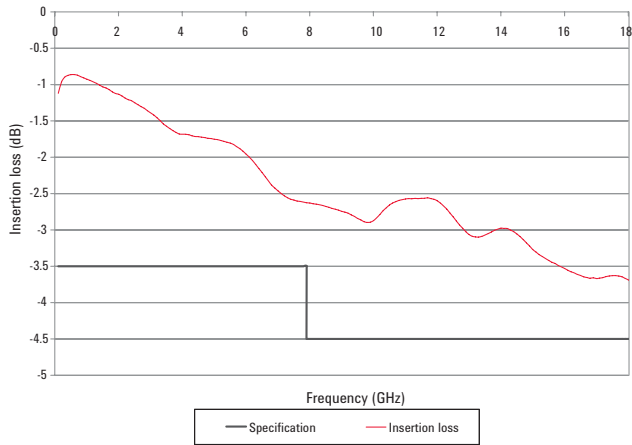

Figure 16. P9404C insertion loss vs. frequency (typical)

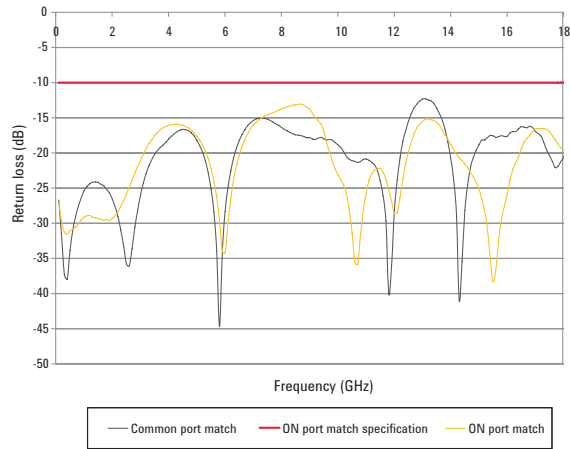

Figure 17. P9404C return loss (ON) vs. frequency (typical)

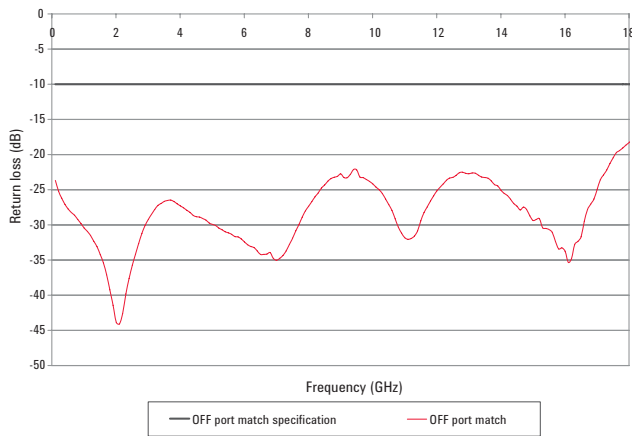

Figure 18. P9404C return loss (OFF) vs. frequency (typical)

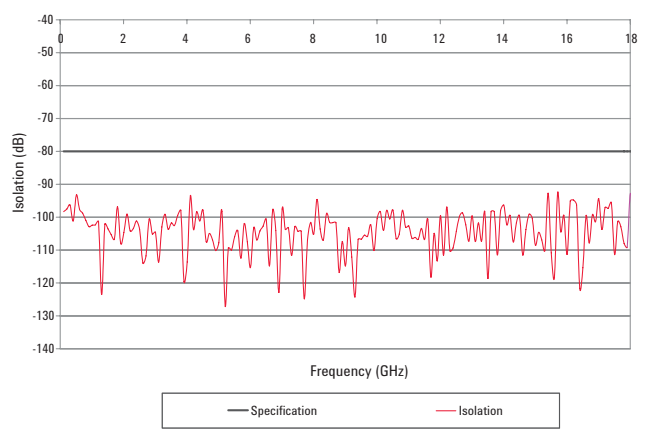

Figure 19. P9404C isolation vs. frequency (typical)

## Ordering Information

- P9402A 100 MHz to 8 GHz SPDT PIN Switch
- P9402C 100 MHz to 18 GHz SPDT PIN Switch
- P9404A 100 MHz to 8 GHz SP4T PIN Switch
- P9404C 100 MHz to 18 GHz SP4T PIN Switch

[www.keysight.com/find/mta](http://www.keysight.com/find/mta)

## Related Literature

Selecting the right switch technology for your application, literature number [5989-5189EN](#)



## Evolving Since 1939

Our unique combination of hardware, software, services, and people can help you reach your next breakthrough. We are unlocking the future of technology.

From Hewlett-Packard to Agilent to Keysight.

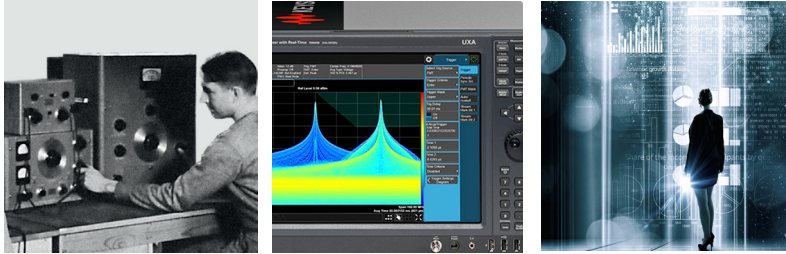

For more information on Keysight Technologies' products, applications or services, please contact your local Keysight office. The complete list is available at:

[www.keysight.com/find/contactus](http://www.keysight.com/find/contactus)

### Americas

Canada	(877) 894 4414
Brazil	55 11 3351 7010
Mexico	001 800 254 2440
United States	(800) 829 4444

### Asia Pacific

Australia	1 800 629 485
China	800 810 0189
Hong Kong	800 938 693
India	1 800 11 2626
Japan	0120 (421) 345
Korea	080 769 0800
Malaysia	1 800 888 848
Singapore	1 800 375 8100
Taiwan	0800 047 866
Other AP Countries	(65) 6375 8100

### Europe & Middle East

Austria	0800 001122
Belgium	0800 58580
Finland	0800 523252
France	0805 980333
Germany	0800 6270999
Ireland	1800 832700
Israel	1 809 343051
Italy	800 599100
Luxembourg	+32 800 58580
Netherlands	0800 0233200
Russia	8800 5009286
Spain	800 000154
Sweden	0200 882255
Switzerland	0800 805353
	Opt. 1 (DE)
	Opt. 2 (FR)
	Opt. 3 (IT)
United Kingdom	0800 0260637

For other unlisted countries:

[www.keysight.com/find/contactus](http://www.keysight.com/find/contactus)  
(BP-9-7-17)

**DEKRA Certified**  
ISO 9001 Quality Management System

[www.keysight.com/go/quality](http://www.keysight.com/go/quality)  
Keysight Technologies, Inc.  
DEKRA Certified ISO 9001:2015  
Quality Management System

This information is subject to change without notice.  
© Keysight Technologies, 2011-2014, 2018  
Published in USA, January 25, 2018  
5989-6695EN  
[www.keysight.com](http://www.keysight.com)

### myKeysight

#### myKeysight

[www.keysight.com/find/mykeysight](http://www.keysight.com/find/mykeysight)

A personalized view into the information most relevant to you.

[http://www.keysight.com/find/emt\\_product\\_registration](http://www.keysight.com/find/emt_product_registration)

Register your products to get up-to-date product information and find warranty information.

### KEYSIGHT SERVICES

Accelerate Technology Adoption.  
Lower costs.

#### Keysight Services

[www.keysight.com/find/service](http://www.keysight.com/find/service)

Keysight Services can help from acquisition to renewal across your instrument's lifecycle. Our comprehensive service offerings—one-stop calibration, repair, asset management, technology refresh, consulting, training and more—helps you improve product quality and lower costs.



#### Keysight Assurance Plans

[www.keysight.com/find/AssurancePlans](http://www.keysight.com/find/AssurancePlans)

Up to ten years of protection and no budgetary surprises to ensure your instruments are operating to specification, so you can rely on accurate measurements.

#### Keysight Channel Partners

[www.keysight.com/find/channelpartners](http://www.keysight.com/find/channelpartners)

Get the best of both worlds: Keysight's measurement expertise and product breadth, combined with channel partner convenience.

[www.keysight.com/find/mta](http://www.keysight.com/find/mta)

