

# Series 2400 SourceMeter® Family



**KEITHLEY**

A GREATER MEASURE OF CONFIDENCE

# Streamline your production with precision voltage and current sourcing

SIMPLE • POWERFUL • UNLIMITED



A unique family of instruments to solve a wide range of challenging applications



# and highly accurate measurement capabilities

Today, there's no reason to buy separate instruments for sourcing and measurement. Every instrument in Keithley's Series 2400 SourceMeter family gives you both capabilities in one compact unit. Each one combines a programmable power source with a highly repeatable, 5½-digit multimeter (DMM) in a half-rack-sized enclosure. You can use it as a voltage source, a current source, a voltage meter, a current meter, and an ohmmeter. There's a SourceMeter solution for just about any DC measurement challenge you can imagine. You can link any of them to a variety of component handlers for fast binning and sorting. Plus, SourceMeter instruments are fully compatible with Keithley's popular switching mainframes and cards for automating high speed, multipoint test applications.

- Perform high speed pass/fail testing and component binning
- Build I/V, I/R, V/I, and V/R curves with high resolution device characterization capabilities
- Measure resistance at any desired voltage or current level
- Source or sink power up to 1000W in pulse mode and 100W DC
- Create sophisticated ATE systems to streamline your production

# Increasing throughput, yield, and productivity has

## Maximize throughput, precision, and accuracy

SourceMeter instruments provide you with high throughput while delivering precision voltage and current sourcing and highly accurate measurements. Each model combines five tightly integrated instruments into one compact half-rack-sized unit: a voltage source, a current source, a voltage meter, a current meter, and an ohmmeter.

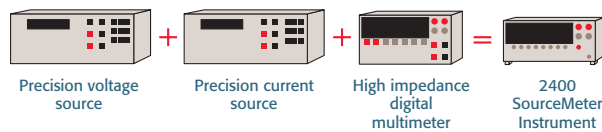

## Increase productivity with high throughput and high yields

With the tight integration of a SourceMeter instrument, you'll get high speeds for high throughput and high measurement accuracy and repeatability for yield integrity. This tight integration also provides significant throughput advantages compared with multiple instrument systems. Each SourceMeter model is both a highly stable DC power source and a true instrument-grade 5½-digit multimeter (DMM). Its power source characteristics include low noise, precision, and readback. Its DMM capabilities include high repeatability as well as low noise.

### Improve throughput with:

- Reading rates of more than 1750 readings/second to GPIB (IEEE-488.1 mode) and 2080 readings/second to memory
- Built-in comparator for pass/fail testing as fast as 500 $\mu$ s per point
- Built-in test sequencer and a 5000-point memory buffer for fast, multi-step tests and for minimizing GPIB traffic
- Keithley's Trigger Link interface for high speed triggering between instruments

### Improve test yields and reduce false failures with:

- Optional contact check to verify good connection to the device under test in less than 350 $\mu$ s
- Basic measurement accuracy of 0.015% for volts, 0.035% for current, and 0.04% to 0.07% for ohms
- Unique 6-wire ohms capability for resistor network testing

### Additional features that increase the usefulness of the SourceMeter family include:

- Fully programmable test signals and device protection thresholds for I, V,  $\Omega$ , and power measurements
- Built-in sweeps for I/V, I/R, V/I, and V/R characterization
- Simplified programming with LabVIEW™ and TestPoint™ drivers
- Digital I/O with automated binning capability and built-in component handler interface
- Industry standard RS-232, IEEE-488.1, and IEEE-488.2 (GPIB) interfaces

## Cost-effective and efficient

A SourceMeter instrument provides a good return on investment. You can expect great reliability, support, and service, as well as the need for only one instrument instead of many. Its compact half-rack size takes up minimal real estate, and its high accuracy measurements and robust design make it very dependable. When you need support or have questions, call our experienced Application Engineers or use the extensive library of application notes and example programs located on our web site. The versatile design and world-class performance of SourceMeter instruments make them ideal for a broad range of design and production applications in fields as diverse as communications, semiconductor, and components manufacturing.

## Easy to use

A SourceMeter instrument is easy to set up and use. It provides convenient DMM-like operation, while eliminating many of the connection, compatibility, and synchronization problems that occur when multiple instruments are used. And, it allows you to source voltage or current while making measurements without changing connections. This not only makes it easier to use, it saves test time.

# never been simpler



## Measure functions operate like a DMM.

## Source functions set up easily.

*Dual-line VFD displays sourced value, measured value, and compliance level.*

*Obms measurements with user-programmable source current or clamp voltage*

*Fully programmable mathematical function key enables on-board calculation of derived parameters, such as power, voltage coefficient, ratio, etc.*

*Sense line impedance of >10GΩ won't disturb measurements.*

*5½-digit resolution provides sensitivity as low as 10<sup>-17</sup> A and 1mV.*

*Source and measure from the same terminals.*

*Reading rates of up to 2080/s into memory, 1750/s over IEEE-488*

*5000-point memory buffer*

*3-stage limit structure for fast pass/fail testing*

*Choose from stair, log, or custom sweeps.*

*Bright, clear "output on" indicator*

*Programmable front/rear switching provides two independent channels that can be switched over the bus.*

HIGH VERSATILITY



*IEEE-488.1 or IEEE-488.2 for instrument control or to download commands for automatic execution. LabVIEW™ and TestPoint™ drivers are available.*

*Guard and Guard Sense lines provide unique 6-wire obms capability to guard out parallel resistors in networks.*

*RS-232 interface for direct connection to PC*

*Trigger Link feature provides two hardware trigger lines for fast, precise, repeatable triggering of switching systems.*

*Component handler interface has binning and pass/fail output.*

# Full range of testing capabilities

The instruments in the SourceMeter family offer wide versatility, so they make great solutions for a variety of applications in many industries. For seamless integration in fast multipoint testing applications, combine a SourceMeter instrument with a Keithley switch system. The examples outlined here represent only a fraction of the potential applications for these powerful test solutions. For details on these applications, including test system configurations, or for additional SourceMeter applications, visit our website at [www.keithley.com](http://www.keithley.com).

SEAMLESS INTEGRATION FOR MULTI-POINT TESTING

## Testing optoelectronic components

Use a SourceMeter instrument to measure a component's electrical performance characteristics and to drive laser diodes and other components.

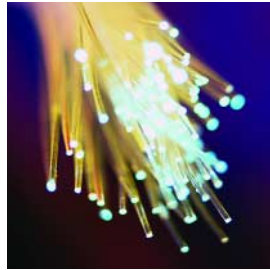

### Types of optoelectronic components:

- Laser diodes
- Laser diode modules
- Photodetectors
- Light-emitting diodes (LEDs)
- Photovoltaic cells

### Typical tests:

- LIV test (laser diodes and LEDs)
- Kink test (laser diodes)
- I-V characterization

## Testing resistors and resistor networks

Use a SourceMeter instrument to verify the performance of resistor networks at various stages in production, as well as in their final packaged form.

### Types of devices:

- Thin-film or thick-film resistors and networks
- Dual terminator networks
- R/2R ladder networks
- Isolated and bussed networks
- Thermistors

### Typical measurements:

- Circuit or buried node resistance
- Standard 4-wire and 6-wire Kelvin
- Percent deviation and ratio
- Isolation and trace resistance
- TCR (temperature coefficient of resistance) testing

## Testing diodes

A SourceMeter instrument is ideal for testing devices with high voltage and high current, such as diodes.

### Types of diodes:

- Switching diodes
- Zener diodes
- Radio frequency (RF) diodes

### DC parametric tests:

- Forward voltage test
- Reverse breakdown test
- Leakage current test
- Polarity test
- Off-line QA analysis

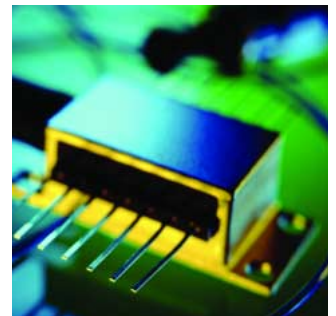



## Testing circuit protection devices

A SourceMeter instrument is ideal for testing circuit protection devices, which can provide fast, energy absorbing, transient and over-voltage protection to a load placed across them.

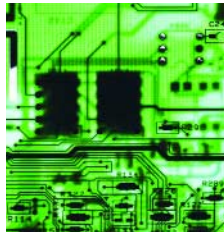

### Types of circuit protection devices:

- TVS (transient voltage suppression)
- MOV (metal oxide varistor)
- Thermistors
- Polyfuses
- Fuses

### Typical tests:

- Bipolar nominal voltage test
- Maximum clamping (breakdown) voltage test
- DC standby (leakage) current test
- Non-linear exponent (alpha coefficient) test

## Testing ICs, RFICs, and MMICs

Use a SourceMeter instrument during the production testing of DC characteristics for a variety of IC technologies.

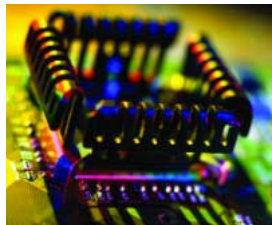

### Typical tests:

- $I_{DDQ}$  test
- DC parametric electrical test
- DC power source test

## Testing air bag inflators

Use a SourceMeter instrument to test the electrical characteristics of the air bag assembly. The precision of a SourceMeter instrument and its readback feature make it ideal for this application, because testing the inflator is much like testing a fuse; if too high a current is used, the fuse will open and must be scrapped.

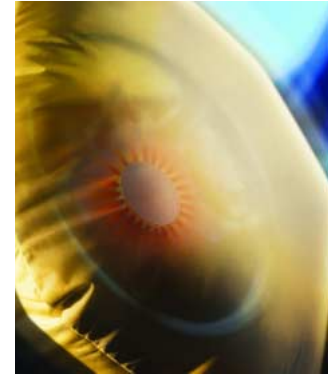

### Typical tests:

- Bridgewire test
- Insulation resistance (HIPOT) test
- Shunt bar test
- Contact verification

## Testing connectors, switches, and relays

Use a SourceMeter instrument to test your connectors, switches, and relays quickly and thoroughly with programmable test currents up to 5A. Quality connectors are vital to ensuring overall product reliability in applications ranging from motor vehicles to transatlantic telecom systems.

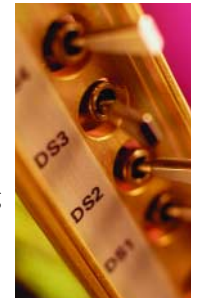

### Typical tests for connectors:

- Isolation (insulation resistance)
- Pin continuity

### Typical tests for connectors, switches, and relays:

- Contact resistance
- Offset compensation
- Insulation resistance
- Dielectric withstanding

## Other applications

- AST (accelerated stress testing), including HALT/HASS and ESS
- GMR (giant magneto-resistive) head testing
- Battery discharge/charge cycling testing
- SOC (system on chip) testing



# Faster, easier, and more efficient testing

FASTER, EASIER, AND MORE EFFICIENT

## Coupled Source and Measure Capabilities

The tightly coupled nature of a SourceMeter instrument provides many advantages over separate instruments. The ability to fit a source and a meter in a single half-rack enclosure saves valuable rack space and simplifies the remote programming interface. Also, the tight control and single GPIB address inherent in a single instrument results in faster test times for ATE applications due to reduced GPIB traffic. The SourceMeter instrument topology (shown below) protects the device under test from damage due to accidental overloads, thermal runaway, and other problems. Both the current and voltage source are programmable with readback to help maximize device measurement integrity. If the readback reaches a programmed compliance limit, then the source is clamped at the limit, providing fault protection.

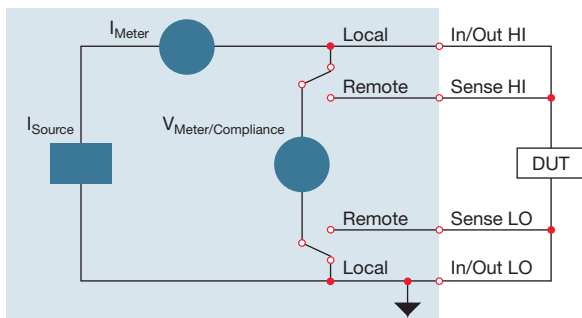

Source I, Measure V, I, or  $\Omega$  configuration

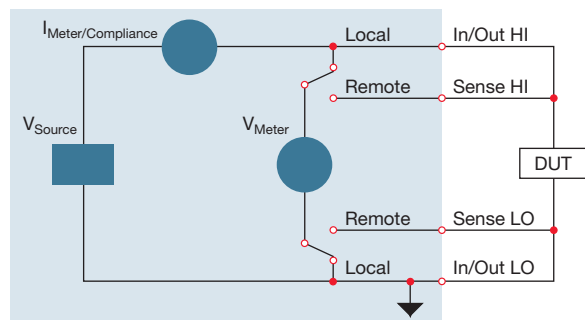

Source V, Measure I, V, or  $\Omega$  configuration

## Six-Wire Ohms Measurements

Use 6-wire ohms measurements to prevent measurement errors or when conventional methods won't work, such as when testing resistor networks, delta networks, and other hybrid circuits. Our unique 6-wire ohms technique uses Guard and Guard Sense leads in addition to the 4-wire Sense and Source leads to guard out parallel current paths when measuring networks or hybrid circuits. This avoids the complication of the DUT being shunted by other resistances in the circuit. This also allows you to test individual resistors buried inside a network without the need to break the circuit to isolate the component under test.

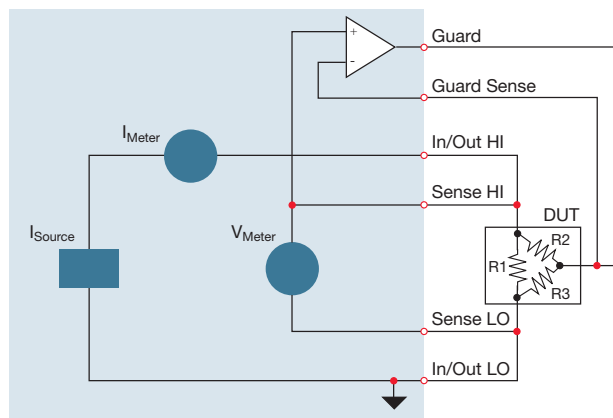

6-Wire Ohms Circuit - All test current flows through  $R1$  because the high current guard drives the voltage across  $R2$  to 0V.

## Contact Check

The optional Contact Check function eliminates measurement errors and false product failures by verifying good connections to the device under test quickly and easily before testing begins. In just  $350\mu s$ , this function's verification and notification routine ensures that you have good contact to a device before sending energy through it and spending time testing it. The Contact Check function was designed for high throughput 4-wire and 6-wire test applications, and it provides three methods of fault notification.

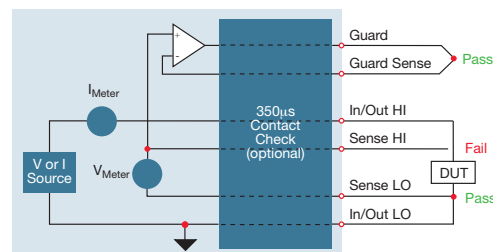

Contact check option for 4-wire or 6-wire applications



# and automation



## Standard and Custom Sweeps

SourceMeter instruments provide sweep solutions that greatly accelerate testing with automation hooks for additional throughput improvement. This is true whether you are performing sweeps on transistors, measuring Varistor Alpha, calculating slope efficiency on VCSELs, simply verifying connector integrity, or characterizing device performance, trip points, transfer functions, or virtually any DC volt-amp characteristic with high precision. Also use it for I/V, I/R, V/I, and V/R characterization.

There are three basic sweep waveforms to select from. The linear staircase sweep goes from the start level to the stop level in equal linear steps. The logarithmic staircase sweep is similar, but is done on a log scale with a specified number of steps per decade. The custom sweep allows construction of special sweeps by specifying the number of measurement points and the source level at each point. All sweep configurations can be programmed for single-event or continuous operation.

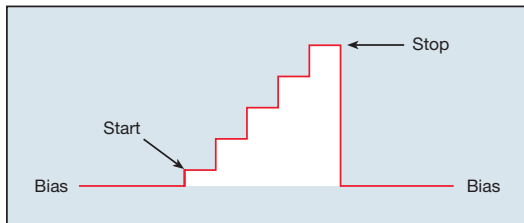

*Linear staircase sweep*

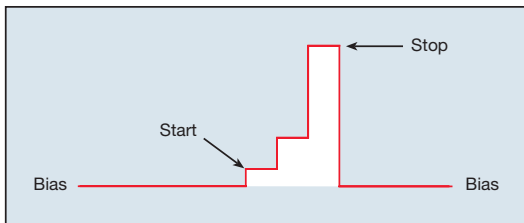

*Logarithmic staircase sweep*

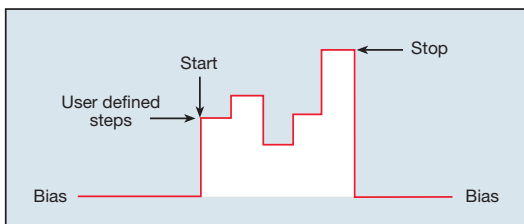

*Custom sweep*

## Built-In Test Sequencer (Source Memory List)

For faster and easier testing, source memory list programmability is provided that allows you to set up and execute up to 100 different tests without PC intervention. Each test can contain different instrument configurations and test conditions, and can include source configurations, measurements, conditional branching, math functions, and pass/fail limit testing with binning capability. In addition, some SourceMeter models can include DC mode or pulse mode with varying parameters and timing (integration, delays, etc.), allowing you to slow down more sensitive measurements and speed up others to optimize overall timing.



# Selecting the best solution for your

All SourceMeter instruments provide four-quadrant operation. In the first and third quadrants, they operate as a source, delivering power to a load. In the second and fourth quadrants, they operate as a sink, dissipating power internally. Voltage, current, and resistance can be measured during source or sink operation.

## Model 2400 SourceMeter Instrument

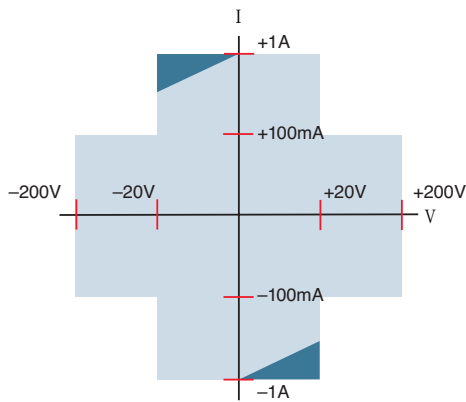

*The Model 2400 is ideal for testing a wide variety of devices, including diodes, resistors, resistor networks, active circuit protection devices, and portable battery-powered devices and components.*

## Model 2420 3A SourceMeter Instrument

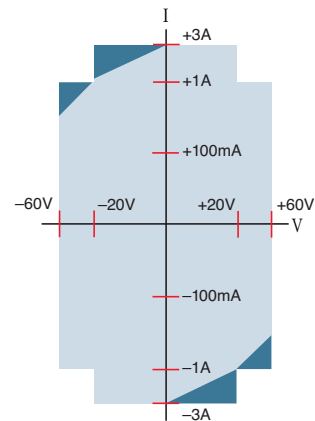

*Choose the Model 2420 for testing higher power resistors, thermistors,  $I_{DDQ}$ , solar cells, batteries, and high current or medium power diodes, including switching and Schottky diodes.*

## Model 2410 High Voltage SourceMeter Instrument

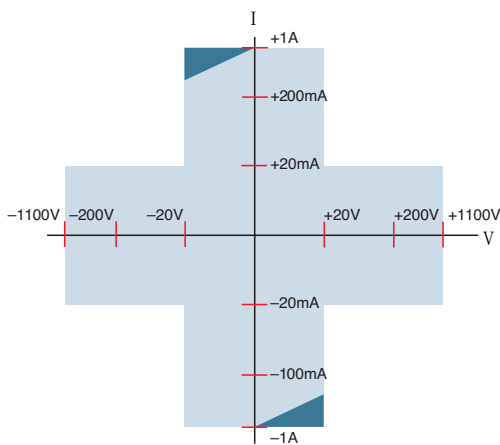

*The Model 2410's high voltage capability makes it a good match for applications such as voltage coefficient testing of resistors, isolation and leakage current testing, and production testing/characterization of high voltage components, including varistors, RF diodes, and rectifiers.*

## Model 2425 100W SourceMeter Instrument

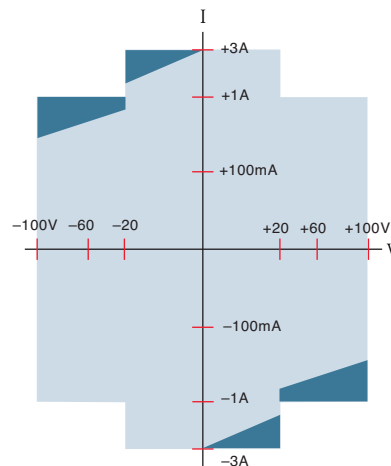

*The Model 2425 offers continuous 100W programmable source and measurement capability for testing DC/DC converters, power semiconductor devices, and other high power components.*

# application



## Model 2430 1kW Pulse Mode SourceMeter Instrument

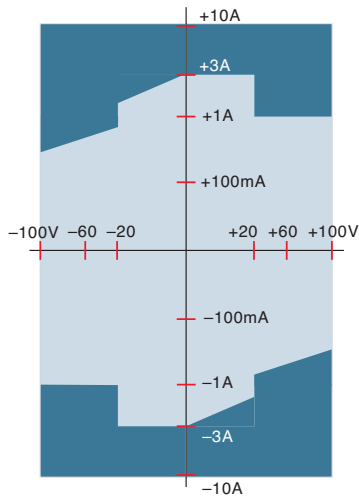

The Model 2430 combines a 1kW pulse capability with continuous 100W programmable source and measurement capability for production testing of devices like multi-layer varistors (MLVs), protection diodes, and other transient suppression devices.

## Model 2440 5A SourceMeter Instrument

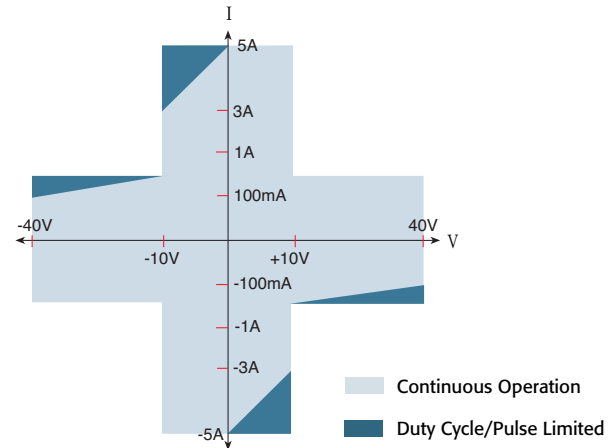

The Model 2440's wide dynamic range is well-suited for applications such as testing high power pump lasers for use in optical amplifiers and laser bar tests, as well as testing other higher power components.

DYNAMIC TESTING CAPABILITIES

Model	2400/ 2400-C*	2410/ 2410-C*	2420/ 2420-C*	2425/ 2425-C*	2430/ 2430-C*	2440/ 2440-C*	6430
<b>Description</b>	General Purpose	High Voltage	3 A	High Power	1000 W Pulse	5 A	Ultra-low Current
<b>Power Output</b>	20 W	20 W	60 W	100 W	100 W	50 W	2 W
<b>Voltage Range</b>	±1 μV to ±210 V	±1 μV to ±1100 V	±1 μV to ±63 V	±1 μV to ±105 V	±1 μV to ±105 V	±1 μV to ±42 V	±1 μV to ±210 V
<b>Current Range</b>	±10 pA to ±1.05 A	±10 pA to ±1.05 A	±100 pA to ±3.15 A	±100 pA to ±3.15 A	±100 pA to ±10.5 A (pulse)	±100 pA to ±5.25 A	±10 aA** to ±105 mA
<b>Ohms Range</b>	<0.2 Ω to >200 Ω	<0.2 Ω to >200 MΩ	<0.2 Ω to >200 MΩ	<0.2 Ω to >200 MΩ	<0.2 Ω to >200 MΩ	<2.0 Ω to >200 MΩ	<2.0 Ω to >20 TΩ***
<b>Applications</b>	<ul style="list-style-type: none"> <li>Resistive devices</li> <li>Diodes</li> <li>Optoelectronic components</li> <li>I<sub>DDQ</sub> testing</li> </ul>	<ul style="list-style-type: none"> <li>Voltage coefficient</li> <li>Varistors</li> <li>High voltage diodes and protection devices</li> <li>Airbag inflators</li> </ul>	<ul style="list-style-type: none"> <li>Power resistors</li> <li>Thermistors</li> <li>Solar cells</li> <li>Batteries</li> <li>Diodes</li> <li>I<sub>DDQ</sub> testing</li> </ul>	<ul style="list-style-type: none"> <li>Power semi-conductors</li> <li>DC/DC converters</li> <li>High power components</li> <li>I<sub>DDQ</sub> testing</li> </ul>	<ul style="list-style-type: none"> <li>High power pulse testing</li> <li>Varistors and other circuit protection devices</li> </ul>	<ul style="list-style-type: none"> <li>5A pump laser diodes</li> </ul>	<ul style="list-style-type: none"> <li>Particle beam experiments</li> <li>SET (single electron transistor) testing</li> <li>Ultra-high resistance testing (up to 10<sup>15</sup>Ω)</li> </ul>

\* A model number ending with "-C" indicates the Contact Check function

\*\* 1aA = 1 x 10<sup>-18</sup> amps

\*\*\* 1TΩ = 10 x 10<sup>12</sup> ohms

# Everything you need to create a customized

## For a fast, efficient, cost-effective system

Keithley can provide you with a wide variety of accessories, switching systems, and support, so you can create a solution that is exactly tailored to your needs. Our Application Engineers can help you decide which configurations are best suited to your situation.

## Switching systems

For your multiple test point applications, combine a Keithley switch system with your SourceMeter instrument for a seamless, complete solution. You can count on our switch systems to provide the characteristics needed to maintain signal integrity and the flexibility to accommodate a wide range of signals.

### Series 7000 Switch Systems

The Model 7001 is a half-rack, 80-channel, 2-slot mainframe with the highest density switching of any half-rack mainframe in the test and measurement market. Its unique front panel display clearly shows the open/closed status of every channel. Programming at the front panel or over the IEEE bus includes parameters such as scan spacing, channel spacing, number of scans, and trigger source.



The Model 7002 is a 10-slot mainframe that can support up to 400 2-pole multiplexer channels or 400 matrix crosspoints. Its unique interactive front panel channel status display offers light-pen programming.



### Series 7000 Switch Cards

These switch cards provide you with sensitivity and accuracy that matches the instrument, so you can achieve seamless interfacing between SourceMeter instruments and the Model 7001 and 7002 High Density Switch Systems.

There are more than 40 types of cards, including multiplexer, matrix, multi-channel relay, thermocouple, scanner, universal adapter, and RF cards.



### Model 707A/708A Switch Matrix Systems

These switch matrix systems offer advanced solutions to test engineers involved in production testing of semiconductor devices, telecommunications equipment and other electronic products. The Model 707A is a 6-slot mainframe for control of up to 576 channels, while the 708A includes a single slot for up to 96 channels.



### Integra Series Switch/Measurement Systems

When you need higher accuracy, use these systems. They also provide you with the functionality of a DMM, a switching system, a data acquisition system, and a data logger in compact, affordable, easy-to-configure packages. With 80- or 200-channel capacity, these systems allow you to choose from a variety of switch/control plug-in modules, so you can easily customize a system to the needs of your application. Choose from GPIB, RS-232, or Ethernet communication options. Outstanding features of the Model 2750 include world-class low power, low ohms performance and dry circuit and offset compensation capabilities.



# test solution



## RF/Microwave Switching

System 40/41/S46 and

Model 7116-MWS RF/Microwave Signal

### Routing Systems

When you need to integrate a variety of RF components, low frequency switching, power switching, and/or digital I/O into one system, our System 40/41/S46 and Model 7116-MWS switching systems will meet your needs. These switching systems provide both standard and custom configurations.



## Optoelectronic Instrumentation

System 25

Keithley's System 25 LIV (light-current-voltage) Test System Kit combines all the DC measurement capabilities required to test laser diode modules with optical power measurement and tight temperature control over the device under test in an integrated instrument package. The LIV test system is configured from proven Keithley instrumentation; the basic configuration can be easily modified to add new measurement functions or to allow for new connections.



### Available Accessories:

#### Communication

KPC-488.2AT, KPCI-488 GPIB/IEEE-488 Interface Boards  
7007-, 7007-2 Double-Shielded, Premium GPIB

#### Cables

7009-5 RS-232 Cable

#### Test Leads

1754 2-Wire Universal 10 Piece Test

#### Lead Kit

5804 Kelvin (4-Wire) Universal 10

#### Piece

#### Test Lead Kit

5805 Kelvin (4-Wire) Spring-Loaded

#### Probes

5806 Kelvin (4-Wire) Oversized

#### Alligator

#### Clip-on Leads

#### Triggering and Control

KPC-TM TriggerMaster Interface

8501-1, 8501-2 Trigger-Link Cables

8502, 8503, 8505 Trigger-Link Adapters

2499-DIGIO Digital I/O Expander

#### Assembly

#### Other

TestPoint Test Development Software

### Model 2502 Dual Photodiode Meter

Designed for Keithley's L-I-V production test systems, the Model 2502 provides two 100V bias sources and two high speed picoammeters in a single half-rack enclosure.

It supplies the voltage bias and current measurement for two photodetectors simultaneously. The Model 2502 is compatible with the Model 2500INT Integrating Sphere for optical power measurements.



### Model 2510/2510-AT Autotuning TEC SourceMeter Instrument

The Model 2510 powers a laser diode's ThermoElectric Cooler (TEC), providing precise P-I-D (Proportional, Integral, and Derivative) temperature control of the device under test. The Model 2510-AT expands these capabilities with a built-in autotuning algorithm. The autotune feature calculates the best P, I, and D coefficients for optimal closed-loop temperature control.

# Specifications

These condensed specifications provide a valuable overview of the SourceMeter family. For complete specifications, visit our web site ([www.keithley.com](http://www.keithley.com)) or call us at 1-888-KEITHLEY (534-8453) to speak with one of our experienced applications engineers or to ask for data sheets of the models that interest you.

## SourceMeter® Family

	2400(-C)	2410(-C)	2420(-C)	2425(-C)	2430(-C)	2440(-C)	6430
Volts Ranges	0.2, 2, 20, 200 V	0.2, 2, 20, 1000 V	0.2, 2, 20, 60 V	0.2, 2, 20, 100 V	0.2, 2, 20, 100 V	0.2, 2, 20, 40 V	0.2, 2, 20, 200 V
Basic V Source Accuracy	0.02%	0.02%	0.02%	0.02%	0.02%	0.02%	0.02%
Basic V Measure Accuracy	0.015%	0.015%	0.015%	0.015%	0.015%	0.015%	0.015%
I Ranges	1, 10, 100 $\mu$ A 1, 10, 100 mA 1 A	1, 10, 100 $\mu$ A 1, 10, 100 mA 1 A	10, 100 $\mu$ A 1, 10, 100 mA 1 A, 3 A	10, 100 $\mu$ A 1, 10, 100 mA 1 A, 3A	10, 100 $\mu$ A 1, 10, 100 mA 1 A, 3 A, 10 A	10, 100 $\mu$ A 1, 10, 100 mA 1 A, 5 A	1, 10, 100 pA 1, 10, 100 nA 1, 10, 100 $\mu$ A 1, 10, 100 mA
Basic I Source Accuracy	0.045%	0.045%	0.045%	0.045%	0.045%	0.045%	0.045%
Basic I Measure Accuracy	0.035%	0.035%	0.035%	0.035%	0.035%	0.035%	0.035%
Ohms Ranges	20, 200 $\Omega$ 2, 20, 200 k $\Omega$ 2, 20, 200 M $\Omega$	20, 200 $\Omega$ 2, 20, 200 k $\Omega$ 2, 20, 200 M $\Omega$	2, 20, 200 $\Omega$ 2, 20, 200 k $\Omega$ 2, 20 M $\Omega$	2, 20, 200 $\Omega$ 2, 20, 200 k $\Omega$ 2, 20 M $\Omega$	2, 20, 200 $\Omega$ 2, 20, 200 k $\Omega$ 2, 20 M $\Omega$	2, 20, 200 $\Omega$ 2, 20, 200 k $\Omega$ 2, 20 M $\Omega$	20, 200 $\Omega$ 2, 20, 200 k $\Omega$ 2, 20, 200 M $\Omega$ 2, 20, 200 G $\Omega$ 2, 20 T $\Omega$
Basic Ohms Measure Accuracy	0.06%	0.07%	0.06%	0.06%	0.06%	0.06%	0.06%

### Additional Source Specifications

**VOLTAGE REGULATION:** Line: 0.01% of range. Load: 0.01% of range + 100 $\mu$ V.

**NOISE 10Hz–1MHz (p-p):** 10mV (50mV typ., Models 2430 and 2440).

**OVER VOLTAGE PROTECTION:** User selectable values, 5% tolerance. Factory default = none.

**CURRENT LIMIT:** Bipolar current limit (compliance) set with single value. Min. 0.1% of range.

**OVERSHOOT:** <0.1% typical (full scale step, resistive load, 10mA range).

**CURRENT REGULATION:** Line: 0.01% of range. Load: 0.01% of range (except Model 2440 5A range 0.5% + 100pA).

**VOLTAGE LIMIT:** Bipolar voltage limit (compliance) set with single value. Min. 0.1% of range.

**OVERSHOOT:** <0.1% typical (1mA step,  $R_L = 10k\Omega$ , 20V range for Model 2400, 2410, 2420, 2425, 2430) (10V range for Model 2440).

**OUTPUT SETTLING TIME:** Time required to reach 0.1% of final value after command is processed. 100 $\mu$ s typical. Resistive load. 10 $\mu$ A to 100mA range.

**DC FLOATING VOLTAGE:** Output can be floated up to  $\pm 250V$  DC (Model 2440  $\pm 40V$  DC) from chassis ground.

**REMOTE SENSE:** Up to 1V drop per load lead.

**COMPLIANCE ACCURACY:** Add 0.3% of range and  $\pm 0.02\%$  of reading to base specification.

### Additional Measure Specification

**SOURCE I MODE, MANUAL OHMS:** Total uncertainty = I source accuracy + V measure accuracy (4-wire remote sense).

**SOURCE V MODE, MANUAL OHMS:** Total uncertainty = V source accuracy + I measure accuracy (4-wire remote sense).

**6-WIRE OHMS MODE:** Available using active ohms guard and guard sense. Max. Guard Output Current: 50mA (except 1, 3, 5, 10A and 1000V ranges). Accuracy is load dependent. Refer to White Paper No. 2033 for calculation formula.

**GUARD OUTPUT IMPEDANCE:** <0.1 $\Omega$  in ohms mode.

### Contact Check Specifications

**SPEED:** 350 $\mu$ s for verification and notification.

CONTACT CHECK:	2 $\Omega$	15 $\Omega$	50 $\Omega$
No contact check failure	<1.00 $\Omega$	<13.5 $\Omega$	<47.5 $\Omega$
Always contact check failure	>3.00 $\Omega$	>16.5 $\Omega$	>52.5 $\Omega$

## System Speeds

### Measurement<sup>1</sup>

MAXIMUM RANGE CHANGE RATE: 75/second.

MAXIMUM MEASURE AUTORANGE TIME: 40ms (fixed source).<sup>2</sup>

### Sweep Operation<sup>3</sup> Reading Rates (rdg./second) for 60Hz (50Hz):

SPEED	NPLC/TRIGGER ORIGIN	MEASURE		SOURCE-MEASURE <sup>5</sup>		SOURCE-MEASURE PASS/FAIL TEST <sup>4,5</sup>		SOURCE-MEMORY <sup>4</sup>	
		TO MEM.	TO GPIB	TO MEM.	TO GPIB	TO MEM.	TO GPIB	TO MEM.	TO GPIB
Fast	0.01 / internal	2081(2030)	1754	1551(1515)	1369	902(900)	981	165(162)	165
IEEE-488.1 Mode	0.01 / external	1239(1200)	1254	1018(990)	1035	830(830)	886	163(160)	163
Fast	0.01 / internal	2081(2030)	1198(1210)	1551(1515)	1000(900)	902(900)	809(840)	165(162)	164(162)
IEEE-488.2 Mode	0.01 / external	1239(1200)	1079(1050)	1018(990)	916(835)	830(830)	756(780)	163(160)	162(160)
Medium	0.10 / internal	510(433)	509(433)	470(405)	470(410)	389(343)	388(343)	133(126)	132(126)
IEEE-488.2 Mode	0.10 / external	438(380)	438(380)	409(360)	409(365)	374(333)	374(333)	131(125)	131(125)
Normal	1.00 / internal	59(49)	59(49)	58(48)	58(48)	56(47)	56(47)	44(38)	44(38)
IEEE-488.2 Mode	1.00 / external	57(48)	57(48)	57(48)	57(47)	56(47)	56(47)	44(38)	44(38)

### Single reading operation reading rates (rdg./second) for 60Hz (50Hz):

SPEED	NPLC/TRIGGER ORIGIN	MEASURE TO GPIB	SOURCE-MEASURE <sup>5</sup> TO GPIB	SOURCE-MEASURE PASS/FAIL TEST <sup>4,5</sup> TO GPIB
Fast (488.1)	0.01 / internal	537	140	135
Fast (488.2)	0.01 / internal	256(256)	79(83)	79(83)
Medium(488.2)	0.10 / internal	167(166)	72(70)	69(70)
Normal(488.2)	1.00 / internal	49(42)	34(31)	35(30)

### Component for 60Hz (50Hz):<sup>4,6</sup>

SPEED	NPLC/TRIGGER ORIGIN	MEASURE TO GPIB	SOURCE PASS/FAIL TEST	SOURCE-MEASURE PASS/FAIL TEST <sup>5,7</sup> TO GPIB
Fast	0.01 / external	1.04 ms (1.08 ms)	0.5 ms (0.5 ms)	4.82 ms (5.3 ms)
Medium	0.10 / external	2.55 ms (2.9 ms)	0.5 ms (0.5 ms)	6.27 ms (7.1 ms)
Normal	1.00 / external	17.53 ms (20.9 ms)	0.5 ms (0.5 ms)	21.31 ms (25.0 ms)

<sup>1</sup> Reading rates applicable for voltage or current measurements. Auto zero off, autorange off, filter off, display off, trigger delay = 0, and binary reading format.

<sup>2</sup> Purely resistive load. 1µA and 10µA ranges <65ms.

<sup>3</sup> 1000 point sweep is characterized with the source on a fixed range.

<sup>4</sup> Pass/Fail test performed using one high limit and one low math limit.

<sup>5</sup> Includes time to re-program source to a new level before making measurement.

<sup>6</sup> Time from falling edge of START OF TEST signal to falling edge of END OF TEST signal.

<sup>7</sup> Command processing time of :SOURCE:VOLTage|CURRENT:TRIGGERed <nrf> command not included.

## GENERAL

### Noise Rejection:

	NPLC	NMRR	CMRR
Fast	0.01	—	80 dB
Medium	0.1	—	80 dB
Slow	1	60 dB	100 dB <sup>1</sup>

<sup>1</sup> Except lowest 2 current ranges = 90dB.

LOAD IMPEDANCE: Stable into 20,000pF typical.

COMMON MODE VOLTAGE: 250V DC (40V DC for Model 2440).

COMMON MODE ISOLATION: >10<sup>9</sup>Ω, <1000pF.

OVERRRANGE: 105% of range, source and measure.

MAX. VOLTAGE DROP BETWEEN INPUT/OUTPUT AND SENSE TERMINALS: 5V.

MAX. SENSE LEAD RESISTANCE: 1MΩ for rated accuracy.

SENSE INPUT IMPEDANCE: >10<sup>10</sup>Ω.

GUARD OFFSET VOLTAGE: <300µV, typical.

#### SOURCE OUTPUT MODES:

- Pulse (Model 2430 only)
- Fixed DC level
- Memory List (mixed function)
- Stair (linear and log)

SOURCE MEMORY LIST: 100 points max.

MEMORY BUFFER: 5,000 readings @ 5 digits (two 2,500 point buffers). Includes

selected measured value(s) and time stamp. Lithium battery backup (3 yr+ battery life).

PROGRAMMABILITY: IEEE-488 (SCPI-1995.0), RS-232, 5 user-definable power-up states plus factory default and \*RST.

#### DIGITAL INTERFACE:

Interlock: Active low input.

Handler Interface: Start of test, end of test, 3 category bits. +5V@ 300mA supply.

Digital I/O: 1 trigger input, 4 TTL/Relay Drive outputs (33V @ 500mA, diode clamped).

POWER SUPPLY: 100V to 240V rms, 50–60Hz (automatically detected at power up). Model 2400: 190VA. Model 2410: 210VA. Model 2420: 220VA. Model 2425, 2430: 250VA. Model 2440: 240VA.

COOLING: (Model 2410, 2420, 2425, 2430, 2440): Forced air, variable speed.

WARRANTY: 1 year.

EMC: Conforms to European Union Directive 89/336/EEC, EN 61326-1.

SAFETY: Conforms to European Union Directive 73/23/EEC, EN61010-1.

WARM-UP: 1 hour to rated accuracies.

DIMENSIONS: 89mm high × 213mm wide × 370mm deep (3½ in × 8¾ in × 14¾ in). Bench Configuration (with handle & feet): 104mm high × 238mm wide × 370mm deep (4¼ in × 9¾ in × 14¾ in).

---

## Informative reference materials

Visit our web site, [www.keithley.com](http://www.keithley.com), to access our reference library, including:

### Switching Handbook

This valuable publication describes relay characteristics, switching specifications, selection criteria, system integration hints, and guidelines for optimizing your test system.



### Low Level Measurements

This informative handbook describes theoretical and practical considerations involved in the measurement of low DC currents, high resistances, and low DC voltages.



### Application Notes

These helpful notes include practical, real-world answers to many application questions related to SourceMeter instruments.

## Service you can depend on

When you need help, contact us at [www.keithley.com](http://www.keithley.com) or call us at **1-888-KEITHLEY (534-8453)**. Whatever your application, Keithley's application engineers are ready to help you meet its challenges, before and after the sale. You can rely on us to suggest the most effective system configurations and to provide prompt, reliable applications support once your system is set up.

The next time you're faced with a challenging application, give us a call. We'll offer you a cost-effective solution that will help you improve your product quality, throughput, and yield.

## Keithley's commitment to the electronics manufacturing industry

Keithley has more than 50 years of experience in applying our world leadership in low-level measurements to produce solutions for your industry's needs. Backed by R&D, customer feedback, partnerships, and strategic alliances, the result has been accurate and reliable DMMs, Source-Measure Units, switching systems, I/V characterization systems, and much, much more. The Series 2400 SourceMeter family continues this tradition, along with our heritage of Quality, Service, Innovation, and Integrity (QSII).

---

Specifications are subject to change without notice.

All Keithley trademarks and trade names are the property of Keithley Instruments, Inc.

All other trademarks and trade names are the property of their respective companies.

**KEITHLEY**

A G R E A T E R M E A S U R E O F C O N F I D E N C E

### Keithley Instruments, Inc.

**Corporate Headquarters** • 28775 Aurora Road • Cleveland, Ohio 44139 • 440-248-0400 • Fax: 440-248-6168 • 1-888-KEITHLEY (534-8453) • [www.keithley.com](http://www.keithley.com)

**Belgium:** Sint-Pieters-Leeuw • 02-363 00 40 • Fax: 02-363 00 64 • [www.keithley.nl](http://www.keithley.nl)

**China:** Beijing • 8610-82251886 • Fax: 8610-82251892 • [www.keithley.com.cn](http://www.keithley.com.cn)

**Finland:** Helsinki • 09-5306-6560 • Fax: 09-5306-6565 • [www.keithley.com](http://www.keithley.com)

**France:** Palaiseau Cédex • 01-64 53 20 20 • Fax: 01-60 11 77 26 • [www.keithley.fr](http://www.keithley.fr)

**Germany:** Germering • 089/84 93 07-40 • Fax: 089/84 93 07-34 • [www.keithley.de](http://www.keithley.de)

**Great Britain:** Theale • 0118 929 7500 • Fax: 0118 929 7519 • [www.keithley.co.uk](http://www.keithley.co.uk)

**India:** Bangalore • 080 212 8027 • Fax : 080 212 8005 • [www.keithley.com](http://www.keithley.com)

**Taiwan:** Hsinchu • 886-3-572-9077 • Fax: 886-3-572-9031 • [www.keithley.com.tw](http://www.keithley.com.tw)

**Italy:** Milano • 02-48 39 16 01 • Fax: 02-48 30 22 74 • [www.keithley.it](http://www.keithley.it)

**Japan:** Tokyo • 81-3-5733-7555 • Fax: 81-3-5733-7556 • [www.keithley.jp](http://www.keithley.jp)

**Korea:** Seoul • 82-2-574-7778 • Fax: 82-2-574-7838 • [www.keithley.com](http://www.keithley.com)

**Netherlands:** Gorinchem • 0183-635333 • Fax: 0183-630821 • [www.keithley.nl](http://www.keithley.nl)

**Singapore:** Singapore • 65-6747-9077 • Fax: 65-6747-2991 • [www.keithley.com](http://www.keithley.com)

**Sweden:** Solna • 08-509 04 600 • Fax: 08-655 26 10 • [www.keithley.com](http://www.keithley.com)

**Switzerland:** Zurich • 01-821 94 44 • Fax: 01-820 30 81 • [www.keithley.ch](http://www.keithley.ch)